

Varenummer: 0102214
 Beskrivelse: Seeger låsering J 380 DIN 472
 Fjederstål

Mål

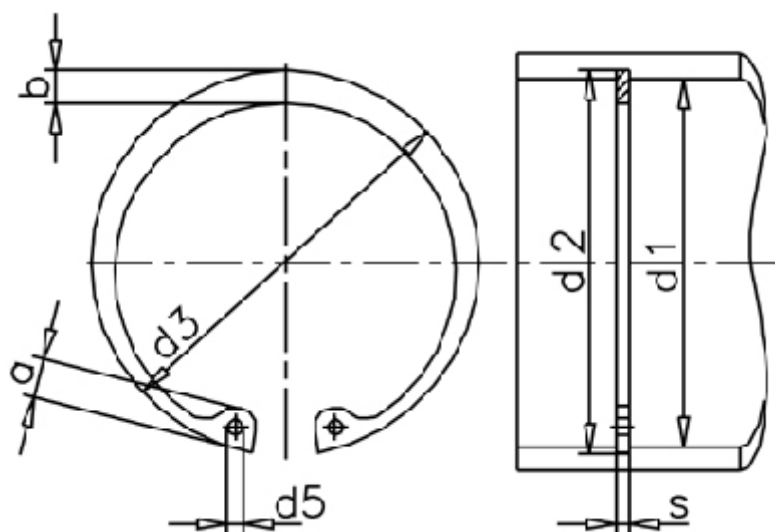

a max	= -	FN kN	= 1008.00	t	= 5.00
AN mm ²	= 6050.0	FRg kN	= 93.0	Tang	= ZGJ-5
b	= 20.0	FR kN	= 784.0	tol	= -0.15
Betegnelse	= J 380	g	= 5.0	tol	= +2,00-0,90
d1	= 380	K kN-mm	= 1796.0	tol	= +0,89
d2	= 390.0	m min	= 6.20	vægt kg/1000	= 940.00
d3	= 397.00	Nominel træk	= 15.0		
d5 min	= 6.0	s	= 6.00		